

488E
Harlo Forklift
With Cummins engine
Installation Instructions



Phone: (519) 485-5961 or 1-800-267-2665

Fax: (519) 485-3745 or 1-888-267-3745

Drive pulley installation:

Steps:

1. An auxiliary pulley is mounted to the fan pulley to drive the compressor. This allows the operation of the A/C compressor to be independent of all other engine functions. The machine will be operable even in the event of a compressor or clutch failure
2. Remove the four bolts holding the fan on the pulley
3. Remove the spacer from the fan pulley.
4. Install the aux. pulley over top of the original fan.
5. Replace the spacer and fan.
6. Align the four bolt holes
7. Bolt the assembly back together using the original bolts. Use medium lock tight on all threads..



Aux. Pulley for the compressor

Picture shows a 310E John Deere backhoe

Compressor installation:

COMPRESSOR: The compressor is mounted on the top left corner of the engine and is run off an auxiliary pulley added to the fan hub.

Steps:

1. Open the engine area to access the radiator fan and compressor mount area.
2. Remove the fan assembly. Install the add-on pulley supplied in the kit. (NOTE) FOR MACHINES WITH A THERMOSTATIC FAN, THE TENSIONER ARM NEEDS TO BE PULLED UP AND THE PULLEY INSTALLED AND THEN THE TENSIONER ARM PUT BACK DOWN. THERE WILL ONLY BE ABOUT 2mm CLEARANCE FROM THE TENSIONER ARM TO THE PULLEY.

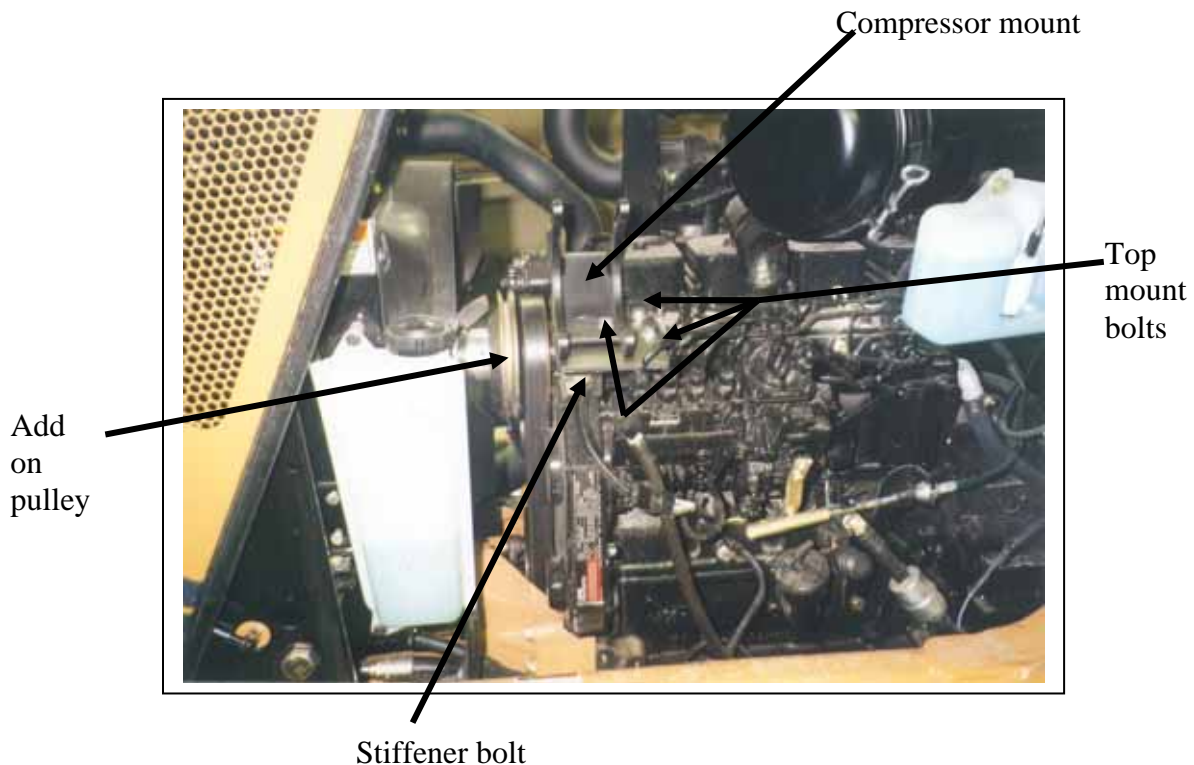

3. Set the compressor mount in place on the top of the engine and secure with the metric hardware provided. Make sure the front stabilizing bolt is in place on the bottom of the compressor mount.
4. Mount the compressor on the compressor mount and secure with the hardware provided. Ensure that the oil fill port is oriented 'UP'.
5. Install the 17400 V-belt over the pulley added onto the fan hub and over the front groove on the compressor. Adjust to the desired tension and secure with the compressor mounting hardware. Check the belt alignment to ensure the mount is on straight.

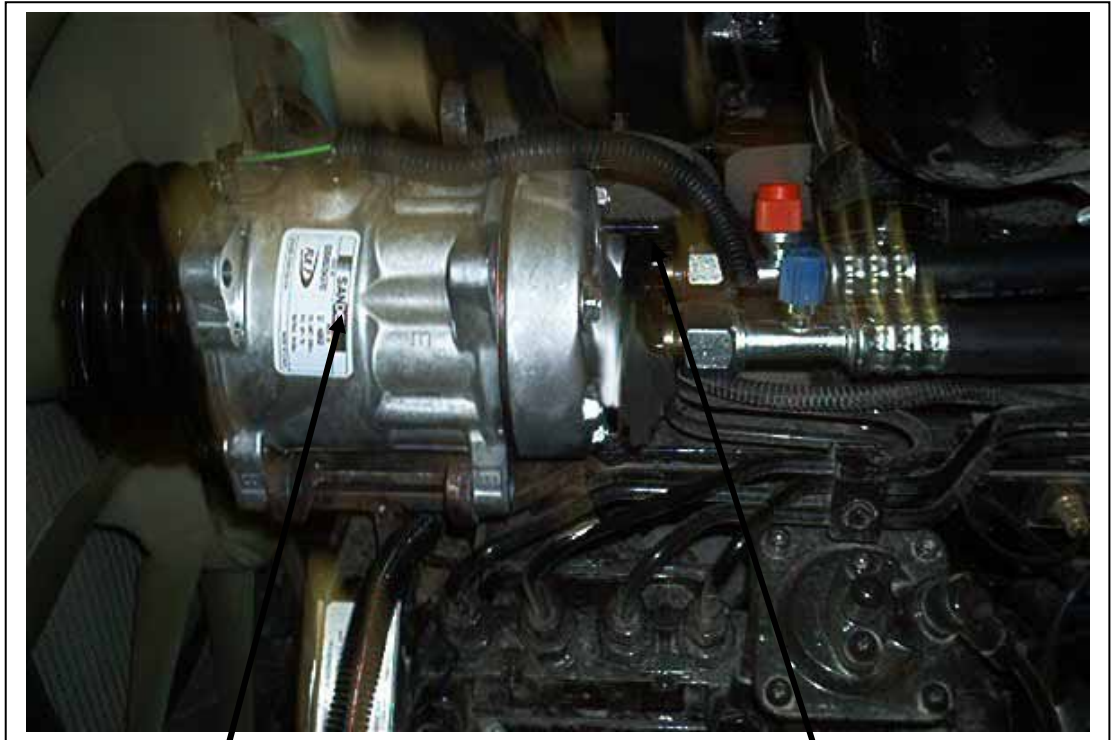

Compressor

Binary switch mounted on high side of pad fitting



6. Install the pad style fitting onto the ports on the back of the compressor. The binary switch will be attached to the high side port on the pad fitting. Attach the A/C lines ensuring that the proper "O" rings are used. Use PAG oil on all contact surfaces and under the nut flange to make the installation easier.
7. Connect the clutch wire coming from the field coil to one side of the binary switch.

Drier mount

Steps:

- 1) Mount the straight drier bracket to the existing M10 bolt on the frame just behind the compressor mount. It has the ground strap on it already.
- 2) Clamp the drier to the bracket using the # 48 gear clamps provided. Have the drier inlet pointing backward and parallel to the engine.

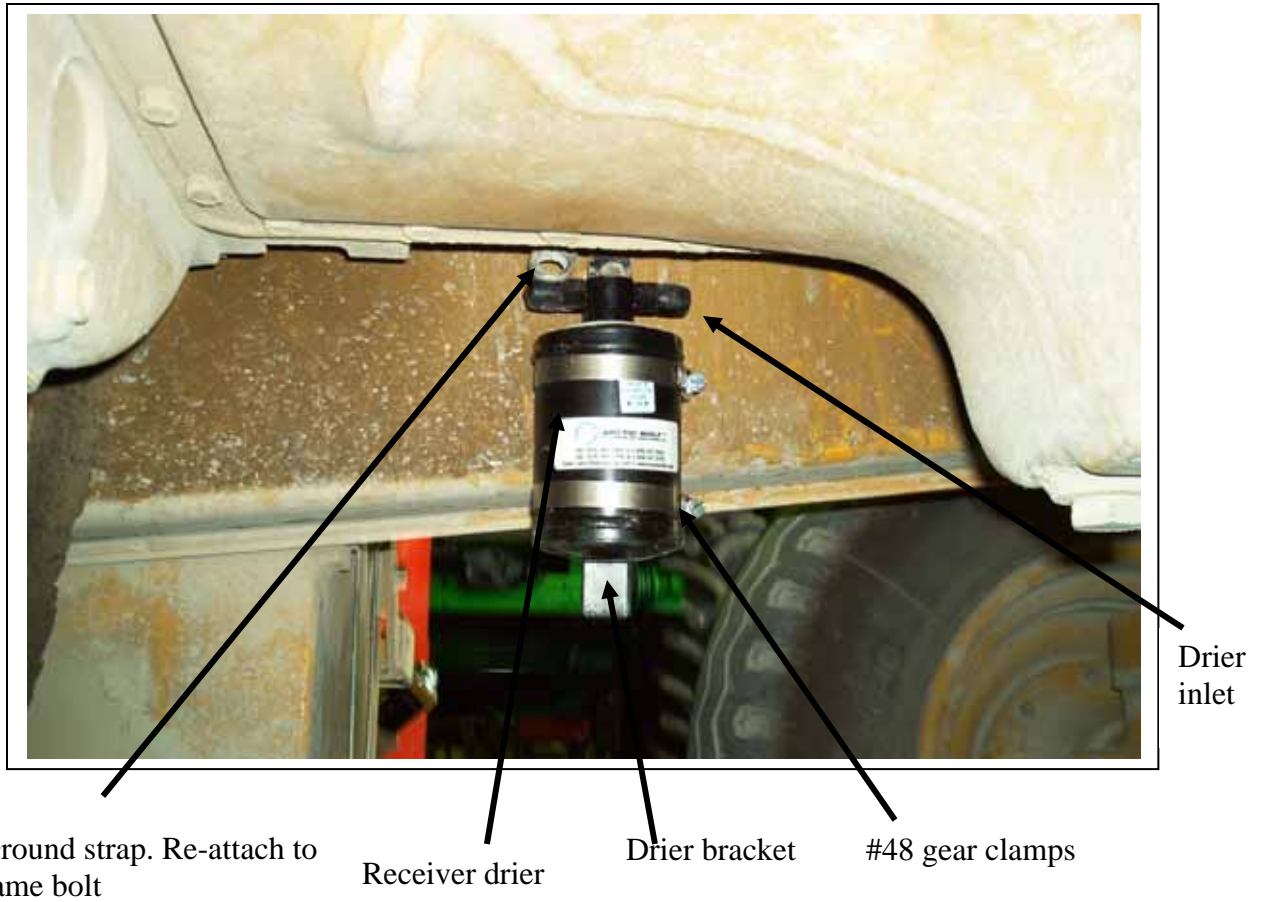

Condenser :

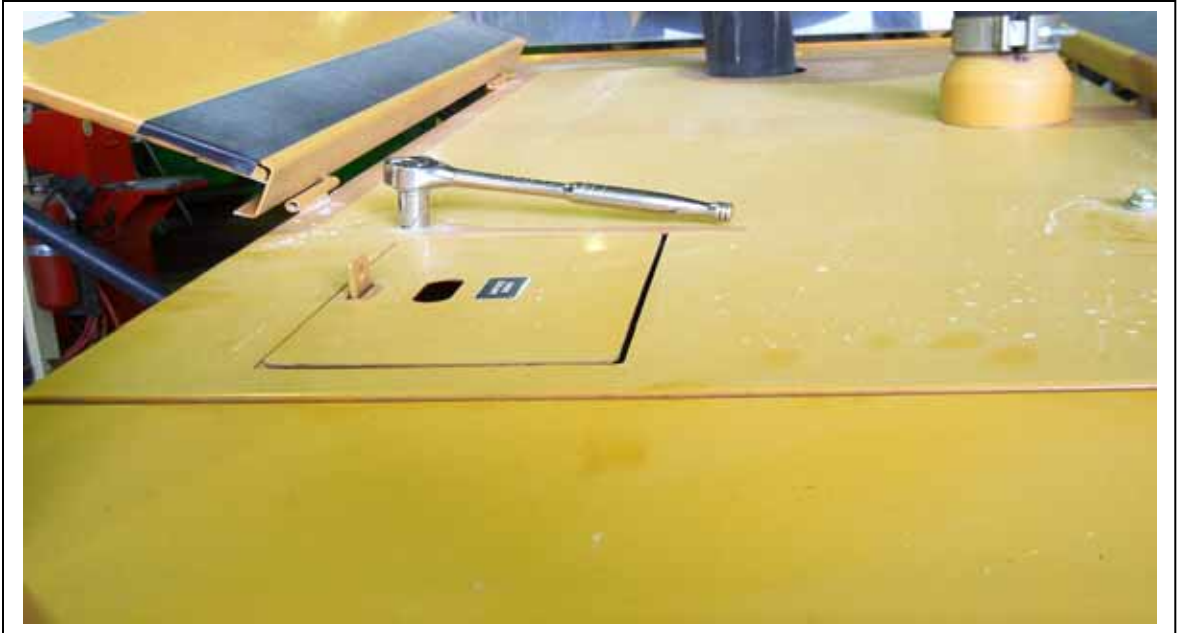

- Unbolt and raise up engine hood.
- Remove the side screens from the radiator area
- If possible remove the counter weight to ease the condenser coil installation.



Loosen the top and bottom mount bolts on both sides of the oil cooler



Loosen and rotate out of the way any hydraulic oil cooler lines affecting the condenser coil installation

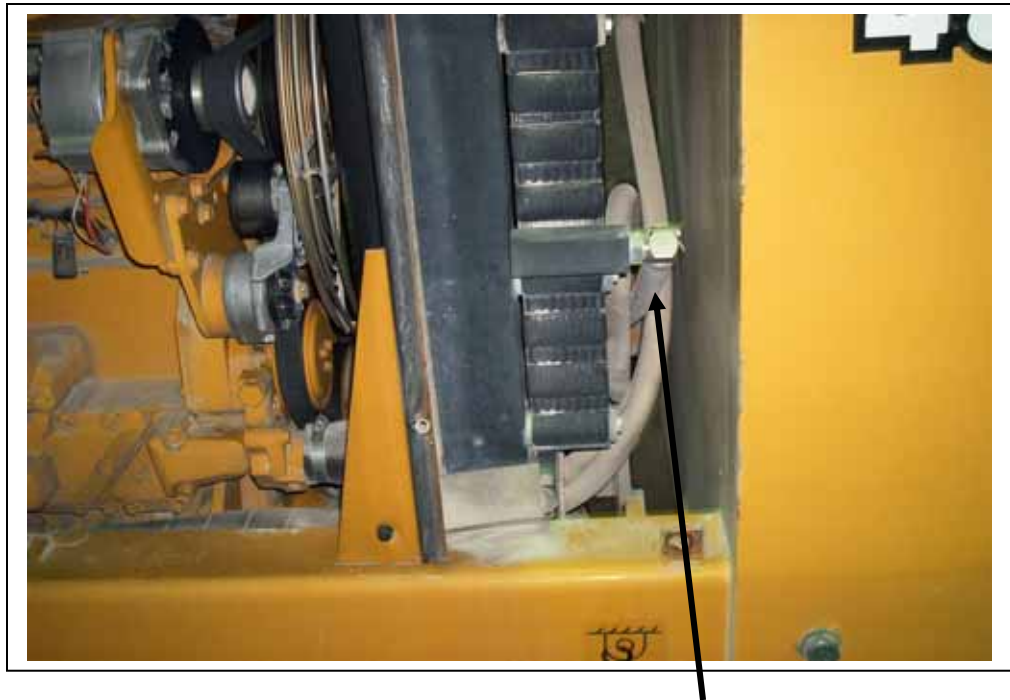

One hydraulic line may have to be lengthened so it can be moved out of the condensers way. Hose, splices and clamps are supplied to do this.



Remount on top hole

Remove for condenser installation. Re-install later. Move it up one bolt hole. Move the bottom mount hole to the top and drill a new top mount hole. This will make room for the condenser coil.

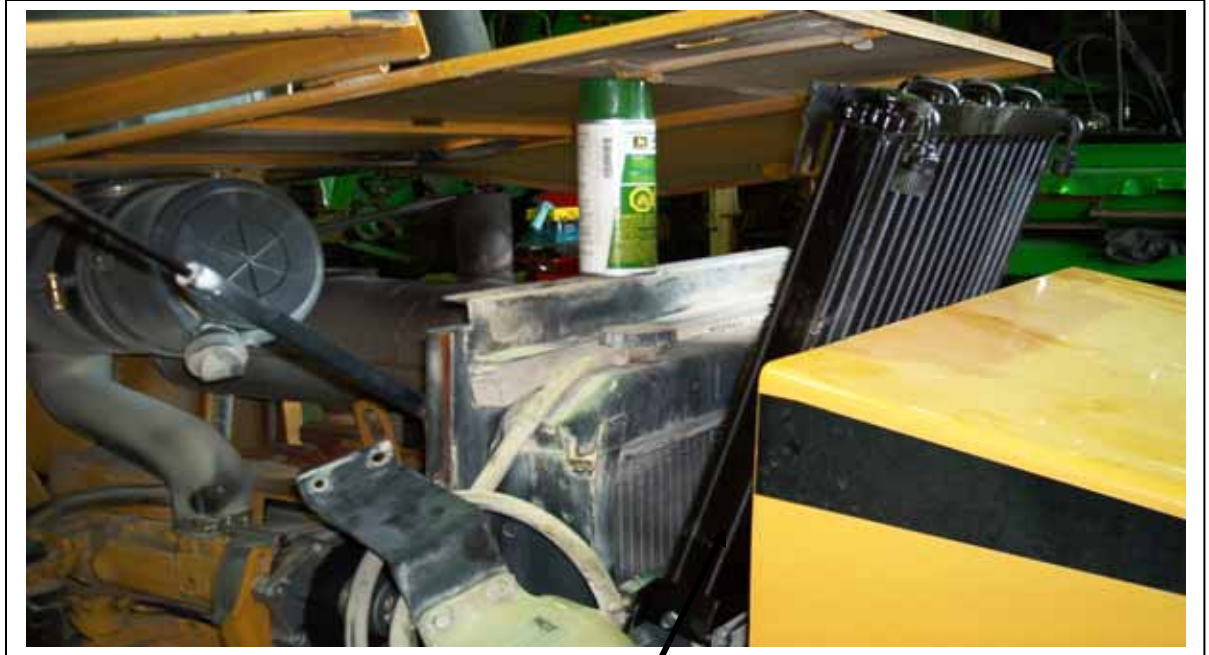

Slide the condenser coil down into place. The fittings go at the top. Condenser shown is not the current design.



Slide the four mount slots behind the washers on the four loosened bolts. Tighten the bolts once all four slots are in place.



5/16" fitting

Oil lines may have to be loosened and moved a little to make room for the condenser.

13/32" fitting



Run the 5/16" hose and the 13/32" hose into the radiator area on the right side of the radiator frame between the foam and the frame

EXTREME DUTY ELECTRIC CONDENSER SET UP (OPTIONAL)



Electric condenser mounted off of back roof of cab.



Left mount bracket. Bolt
bracket to cab roof.

Right mount bracket.
Bolt to cab roof.



Power wire
from relay.

13/32": hose to
compressor.

5/16" hose to drier.



Drill two 1 3/16 holes for universal grommets. Run hoses and power wire through grommet.

Hoses running across back of cab.



Relay control power spliced into the compressor clutch wire. Condenser fans run whenever the compressor is on.

Inline ATO fuse holder and 25 Amp ATO fuse drawing power off the starter.

12 volt 30 amp relay in this area.

Evaporator



Remove the seat

Remove the floor plate

Remove the seat pedestal



Cab with seat pedestal and floor plates removed



Put the box in place and bolt to the back wall of the forklift using the original hardware. The A/C hoses and wiring are all pre attached to the box and run down under the tank at the back of the cab on the right side.

Remove the front face of A/C box before installing in the cab.



Remove the box lid to install the seat. There are four slotted holes for the seat installation. Use the original hardware.

When installing the air distribution channels, put silicone on the flange on the channel to seal it to the box.

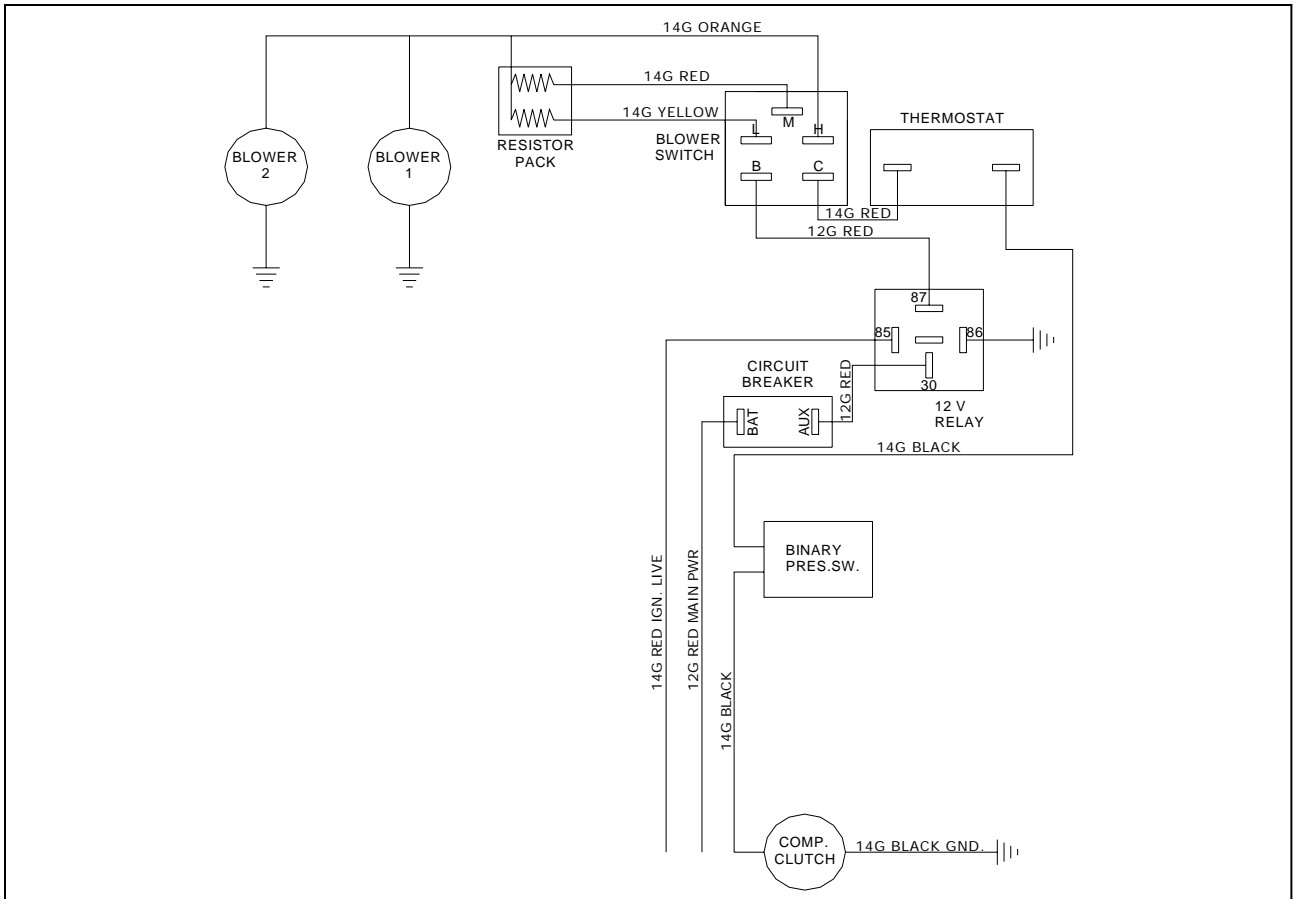

Refrigerant Flow Pattern in a Standard Air Conditioning System

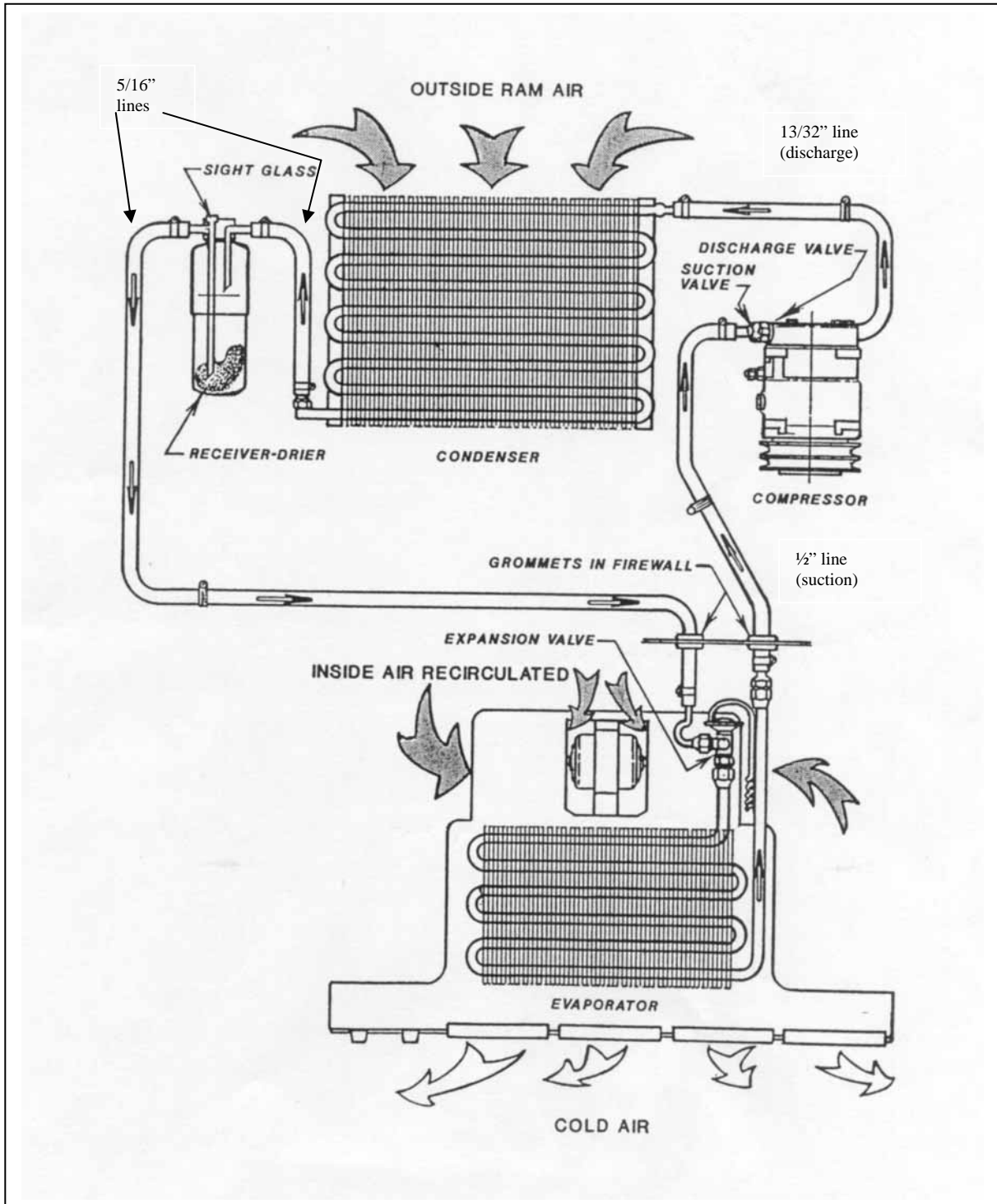

Thermostat Setting Procedures

- 1) Thermostat types
 - a) preset
 - b) adjustable
 - a) A preset thermostat is adjusted to its specific cut in and cut out temperatures when manufactured and does not have a rotary adjustment for the operator.
 - b) An adjustable or rotary thermostat has been manufactured to a predetermined cut in and cut out temperatures, but it is also operator adjustable to achieve the desired comfort level.

Both types of thermostats can have their factory settings adjusted by turning the setting screws on the body of the thermostat. One body type has the setting screws mounted externally and labeled for direction of rotation. The other body type requires the removal of the plastic end plate to expose the set screw.

- 2) Thermostat probe location: The location of the thermostat probe in an evaporator coil can be very important to achieve the maximum cooling potential of the coil while also preventing coil freeze-up. There is no set location for the thermostat probe to be put that will be optimum for all systems, but several rules of thumb may be followed:
 - a) Insert the probe in the coldest area of the evaporator coil.
 - b) Insert the probe from the top of the coil down, if possible.
 - c) Make sure that at least the last 3" of the thermostat probe are in the coil.

To find the most likely area where the coil is the coldest, consider these factors:

- 1) Direction of air flow through the coil.
 - 2) The coil area likely to have the lowest air flow.
 - 3) The inlet locations of the refrigerant into the coil.
 - 4) The inlet of the hotter outside air into the coil area.
-
- 1) Usually the coldest side of the evaporator coil will be the air outlet side. Often the thermostat probe can be inserted between the last and second last row of tubes.
 - 2) The lower air flow area of the evaporator coil in most systems tends to be near either end of the coil. These areas will be colder
 - 3) The area of the coil that the refrigerant inlet tube(s) occupy should be the coldest part of the coil.
 - 4) If the system is equipped with an outside air intake, where and how that air is brought into the evaporator area can have a large effect on the coil temperature. If all the outside air is piped into the evaporator in one area, that area will be considerably warmer in hot weather.

By looking at all these different factors, the area of an evaporator coil most likely to be the coldest can be determined.

Once the probe is inserted, the A/C system needs to be tested. Run the system to ensure that the thermostat is cycling the compressor off at the appropriate temperature. A core temperature ranging between 25° and 30° F should cause the thermostat to cycle off. The air temperature at the vent outlet closest to the evaporator coil should be between 38° F and 45° F when the compressor cycles off.

If the thermostat doesn't cycle off after a reasonable cool down period, and the air outlet temperature has dropped below 40° F, the cut in and cut out settings should be adjusted until the compressor is cycling on and off regularly. Let the system run for a decent time period (at least 15 min) and then check the evaporator coil for any signs of freezing.

Aeroquip E-Z Clip Assembly Instructions

Step 1. Cut the hose to proper length with an appropriate cutting tool. Aeroquip's hand held hose cutter has been specially designed for cutting all non-wire reinforced hose, such as GH-134 Multi-Refrigerant hose. Be sure the cut is made square to the hose length.

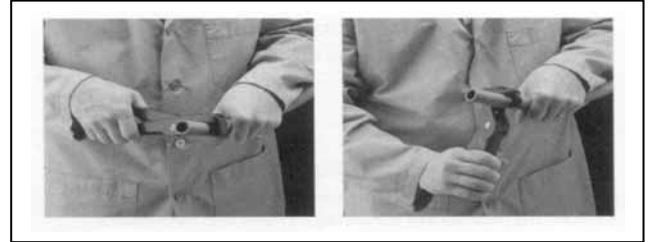

Step 2. Install two proper-sized clips onto the cut end of the hose. Orientation of the clips does not affect the performance of the connection. However, for ease of assembly, both clips should have the same orientation. NOTE: Failure to slide the clips over the hose at this time will require the clips to be stretched over the hose or fitting later. This may permanently damage the clip.



Step 3. Lubricate the nipple with a generous amount of the refrigeration or A/C system's compressor lubricating oil. This MUST be done to lower the force of nipple insertion.

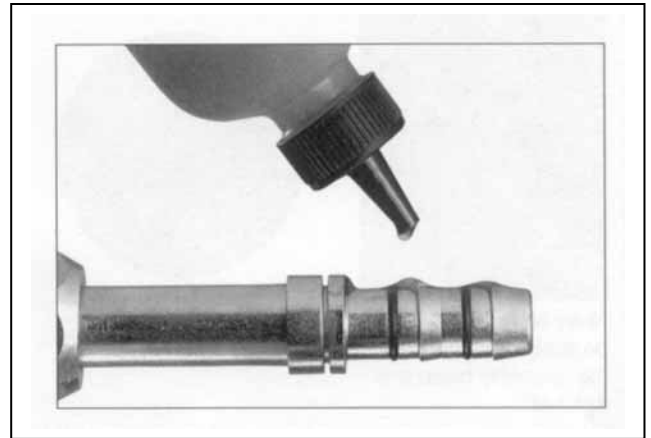

Step 4. Insert the nipple into the hose. To ensure that the nipple is fully inserted, check the gap between the cut end of the hose and the shoulder on the nipple. Care should be taken to avoid kinking or other damage to the hose during nipple insertion. NOTE: Be sure to wipe excess oil from the nipple and hose.



Step 5. Snap the cage into the groove on the nipple. The arms should extend over the hose length. When the cage has been correctly installed in the cage groove, the cage will be able to rotate in the groove.

This step **MUST** be performed to ensure:

1. The clips will be located over the O-rings on the nipple.
2. The connection will be compatible with the connection's pressure rating.

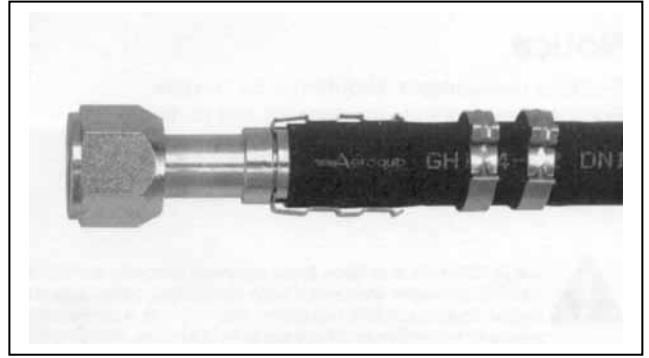

Step 6. Slide the clips over the cage arms and into the channels on each arm.

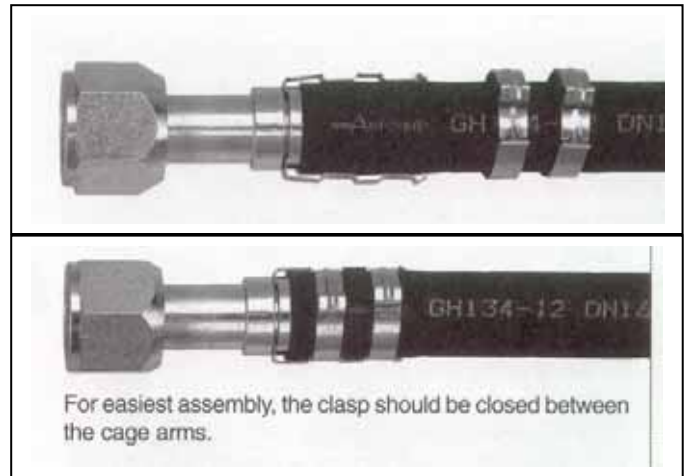

Step 7. Use the pliers to close the clips. The pliers should be positioned squarely on the clip connection points and should remain square during the closing of the clip.

NOTICE: E-Z Clip components should not be reused.

